

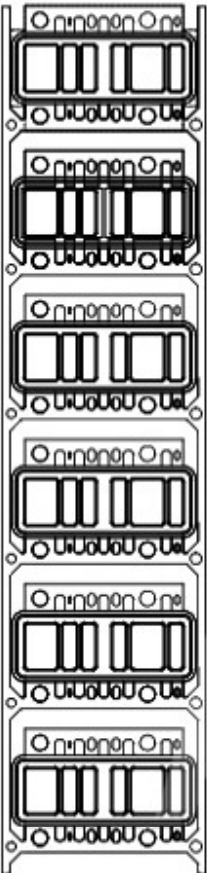

公差 TOLERANCE	
5 以下	±0.05
5 ~ 25	±0.1
25 ~ 80	±0.2
80 以上	±0.3

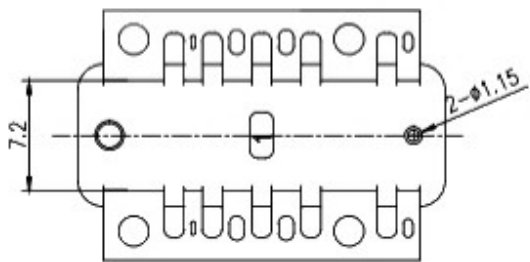
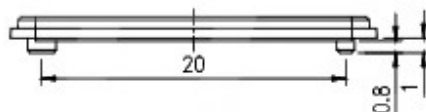
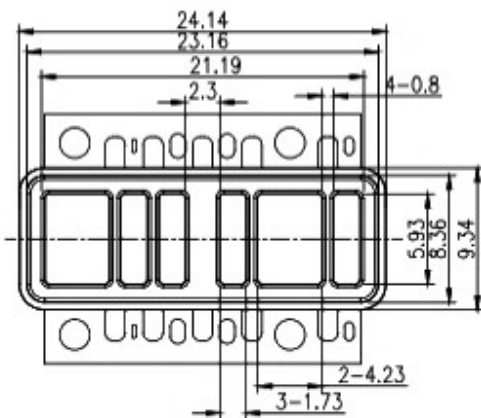
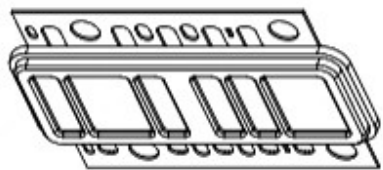

SCALE:1:2

RoHS Compliant

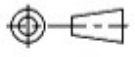
编号: ITEM NO.	材料: MATERIAL	C5191-H/LCP	表面处理: FINISHING	Au Plated	产地: ORIG						
品名: ITEM NAME	腔数: CAVITY	24.1*11.8*2.4	单位: UNIT	mm	比例: SCALE	4:1	制图 DESIGN	检查 CHECK	审批 APPROVED		
图纸编号: DRAWING NO.	公差: TOL.	±2'	版本: VERSION	0	页次 总页: PAGE	2/2					
 东莞市溪榜电子有限公司			 第三角投影		日期: DATE	日期: DATE	日期: DATE	修改 REV.	修改日期 DATE	修改内容 REVISION CONTENT	审批 APPROVED